

VALUE SERIES® Accessories

Strikes

All required strikes are provided with exit devices. Replacement strikes are available as follows:



99 Surface - non-roller strike for V40 Series Rim Devices

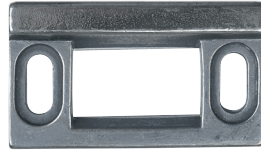

98 Semi-Mortise - applied strike for V40NS Series Rim Devices



96 Top Surface - non-roller top strike for V50/51 Series Surface Vertical Rod Devices



96 Bottom Dust Proof Strike - for V50 Series Surface Vertical Rod Devices

Through Bolt Mounting Plate Kit for SVR

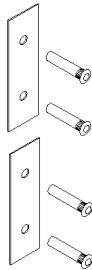

TMP1 - Through Bolt Mounting Plate Kit for use when replacing surface vertical rods on doors that are damaged or to cover existing exterior holes from previous device.

Kit is standard with two 630 finish plates and four 1/4-20 sex bolts. Contact factory for other finishes.

Cylinders



MC65 Mortise Cylinder - 1-1/8" 6-pin, keyed 5-pin. Available keyed alike or keyed differently. Finishes available: 605, 606, 612, 613, 626

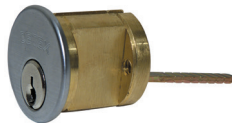

RC65 Rim Cylinder - 6-pin, keyed 5-pin. Available keyed alike or keyed differently. Finishes available: 605, 606, 612, 613, 626



IC7 Interchangeable core cylinder housing - 7-pin, factory installed

Cylinder Collars

Cylinder Collars for 5 and 6 pin cylinders are provided with all outside trim.



CCS 7/16" Short Cylinder Collar - Cylinder collar for 5 and 6 pin cylinders. Finishes available: 605, 606, 612, 613, 625, 626

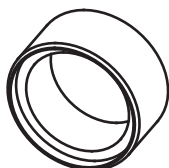

CCL 11/16" Long Cylinder Collar - Cylinder collar for 7 pin interchangeable core cylinders. Finishes available: 605, 606, 611, 612, 613, 625, 626

Cylinder Bracket Kit

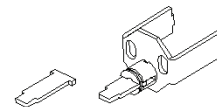

CBK - Cylinder Bracket Kit consists of bracket and adjustable tailpiece assembly for rim cylinder used with other manufacturer's outside trim

Security Screw Kits

Contains an assortment of screw sizes and types for securing covers in place

SSK3 - Security Screw Kit contains all screws and driver bits to secure the cover, end cap and the strike of the exit device.

Additional Security Driver Tips:

TT-10 - Driver tip for 6-32 Undercut FH screws

TT-27 - Driver tip for 1/4-20 and #14 screws

Bolt Guard (V50 Only)



BG - Bottom Bolt Guard - 12" ADA ramped cover (630 Stainless Steel)

Rod Cover (V50/51 Only)



RC - Rod Covers (630 Stainless Steel)

(Top Rod cover shown)

Gate Plate

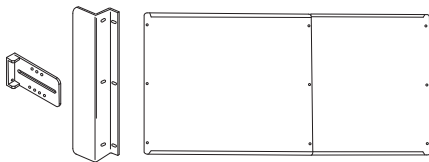

GTPKIT - Adjustable gate plate fits gates 32" - 52" wide. Fits square or round gate frames.

Sex Nut Kit



SN1 - Sex Nut Kit 1/4-20 — 2 per package

Narrow Stile Door Kits

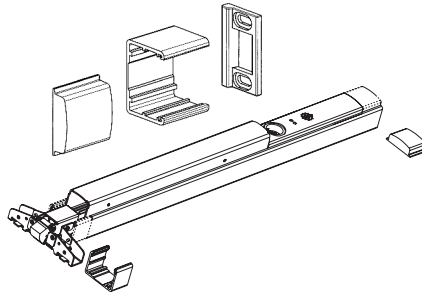

NSK - Narrow Stile Door Kit converts standard Value Series panic device into narrow stile panic device. Required when Value Series exit devices are applied to 36" and 48" glass doors with minimum 2" stiles.

Tools



HDK - Hex Dogging Key - Heavy-duty with overmolded ABS, dogging key is ergonomically designed to resist repetitive motion injuries.

Glass Bead Kits

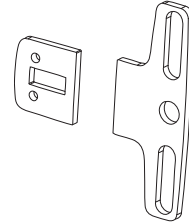

For use on doors with raised glass beads. Each kit contains one 1/4" shim set. Specify Kit number

Kit Number	For use with:
GB15	V40 Series

Key Stop Kit (Set Screw) Alarm always armed when key is removed

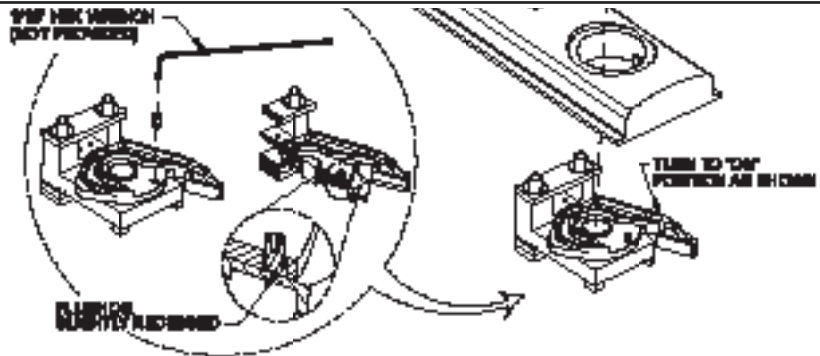

Gate Plate Cylinder Trim



03GS - Optional 03 function cylinder trim used on gates (Rim cylinder sold separately)

Where Trust is Built™
DETEX®
 Life Safety and Security Door Hardware

Detex Corporation
 302 Detex Drive
 New Braunfels, Texas 78130-3045 USA
 PH. (830) 629-2900
 (800) 729-3839
 FAX (830) 620-6711
 (800) 653-3839
<http://www.detex.com>
 USA Sales:
marketing@detex.com
 International Sales:
export@detex.com