

Available Now At



Click Here

HES

FOLGER ADAM

INTEGRATED PRODUCTS

CABINET LOCKS

ACCESSORIES

GENERAL INFORMATION



The 8000 Series is also available in a Complete One Box Solution

# 8000 Series

## The concealed electric strike solution for cylindrical locksets

Shown with 801 Option

The 8000 series is a compact, high performance electric strike featuring a unique concealed design for use with cylindrical locksets. No cutting on the frame is required. Simply remove the existing strike plate, adjust the vertical alignment feature to the latchbolt centerline, and install. Its strength is derived from a unique keeper pin locking design, enabling the 8000 to exceed the ratings of the frame, door and locking hardware. This field selectable fail secure/fail safe unit is easy to install and accommodates latchbolts up to 5/8" throw.

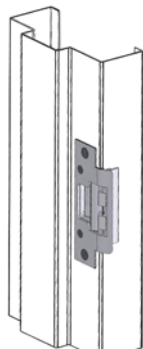

### Specifications

- UL 1034, burglary-resistant listed and suitable for outdoor use
- ANSI/BHMA A156.31, Grade 1
- Patents: 5,934,720; 8,146,966; 8,157,302; 8,465,067

### Electrical

- .24 Amps @ 12VDC/VAC
- .12 Amps @ 24VDC/VAC
- DC continuous duty/ AC intermittent duty only

### Frame Application

- Metal
- Wood

## 8000 Models

### 8000

Universal electric strike  
Faceplate options ordered separately, see page 38

### 8000C

Complete electric strike  
Includes the 801 and 801A faceplates in the box



Model 8000C includes a 801 and a 801A faceplate in the box

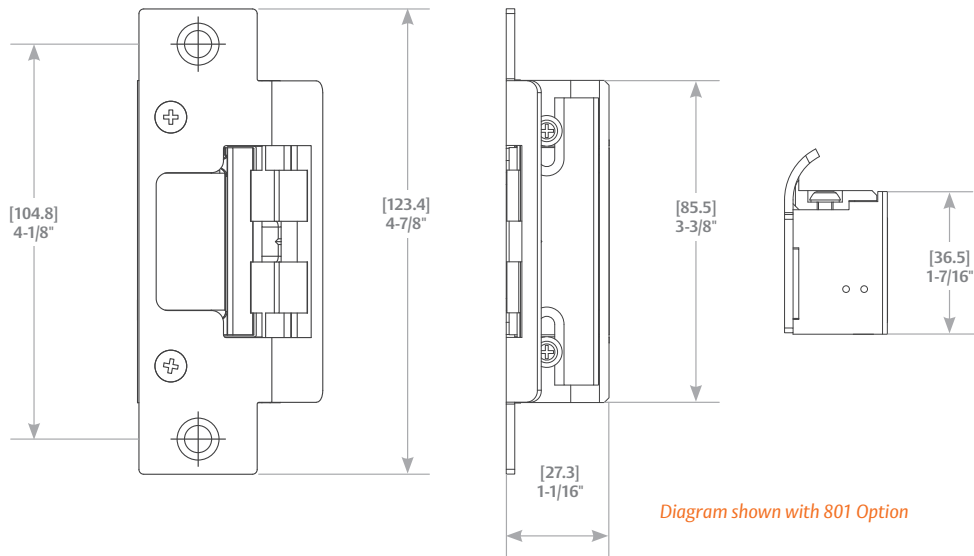

### Standard Features

- No cutting on frame required
- Vertical adjustability to accommodate door sag and misalignment
- Tamper resistant
- Static strength 1,500 lbs.
- Dynamic strength 70 ft-lbs.
- Endurance 500,000 cycles
- Field selectable fail safe/fail secure
- Dual voltage 12 or 24 VDC/VAC
- Non-handed
- Internally mounted solenoid
- Accommodates 1/2" – 5/8" cylindrical latchbolt (5/8" with 1/8" door gap)

- Strike body depth 1-1/16"
- Strike body width 1-7/16"
- Five-year limited warranty

### Optional Features

- **LBM** » Latchbolt monitor

### Accessories

- 2001M** » Plug-in bridge rectifier
- 2004M** » ElectroLynx® adapter
- 2005M3** » SMART Pac® III
- 2006M** » Plug-in buzzer

### Finishes

- 630** » Satin stainless
- 605** » Bright brass
- 606** » Satin brass
- 612** » Satin bronze
- 613** » Bronze toned
- 629** » Bright stainless steel
- BLK** » Black

\*Complete Pacs are only available in the 630 finish



CYLINDRICAL  
LOCKSETS



FIELD SELECTABLE  
(12 OR 24VDC)



FIELD SELECTABLE  
(FAIL SECURE / FAIL SAFE)



GRADE 1



OUTDOOR RATED















UL 1034  
BURGLARY LISTED

**hes**  
ASSA ABLOY

# 8000/8300 Series Faceplate Options



**Operation:** After releasing the latchbolt, the keeper returns to the locked position

 <p>4-7/8" x 1-1/4"</p>	<p><b>801 Option</b></p> <p><b>For use with:</b> Cylindrical locksets in ANSI metal jambs, with latchbolts up to 5/8" throw</p> <p>» ANSI/BHMA Numbers: E05031, E09321, E09322, E09323</p>	
 <p>4-7/8" x 1-1/4"</p> <p><i>Radius corners and flat faceplate</i></p>	<p><b>801A Option</b></p> <p><b>For use with:</b> Cylindrical locksets with latchbolts up to 5/8" throw. Includes universal mounting tabs. Aluminum frames.</p> <p>» ANSI/BHMA Numbers: E05031, E09321, E09322, E09323</p>	
 <p>4-7/8" x 1-1/4"</p> <p><i>Extended lip</i></p>	<p><b>801E Option</b></p> <p><b>For use with:</b> Extended lip for 'knock-down' style frame installations. For use with cylindrical latchbolts up to 5/8" throw.</p> <p>» ANSI/BHMA Numbers: E05031, E09321, E09322, E09323</p>	
 <p>7-15/16" x 1-7/16"</p>	<p><b>802 Option</b></p> <p><b>For use with:</b> Cylindrical locksets with latchbolts up to 5/8" throw. Includes universal mounting tabs. Aluminum frames.</p> <p>» ANSI/BHMA Numbers: E05031, #E09321, E09322, E09323</p>	
 <p>6-7/8" x 1-1/4"</p> <p><i>Radius corners and flat faceplate</i></p>	<p><b>803 Option</b></p> <p><b>For use with:</b> Cylindrical locksets with latchbolts up to 5/8" throw. Includes universal mounting tabs. Aluminum frames.</p> <p>» ANSI/BHMA Numbers: E05031, E09321, E09322, E09323</p>	
 <p>9" x 1-3/8"</p> <p><i>Radius corners and flat faceplate</i></p>	<p><b>805 Option</b></p> <p><b>For use with:</b> Cylindrical locksets. For use with latchbolts up to 5/8" throw. Four point mounting for wood installations.</p> <p>» ANSI/BHMA Numbers: #E05031, #E09321, #E09322, #E09323</p>	

# Reduce your install time by evaluating your opening

The 8000/8300 can be adjusted to compensate for frame and door irregularities. Sometimes, adjusting the frame and door back to industry standards is just not an option. Here are some tips to quickly compensate for frame twist and determine the condition of the latch bolt.

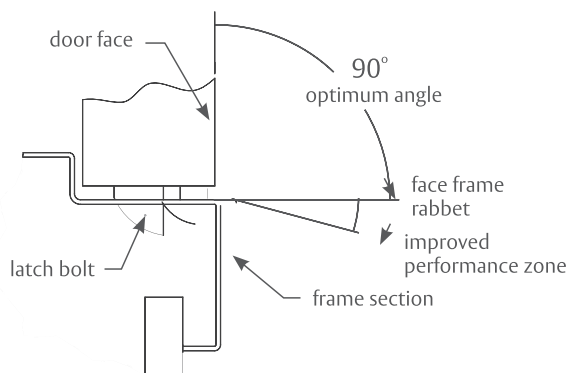

Figure 1

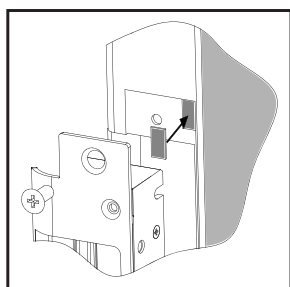

Figure 2

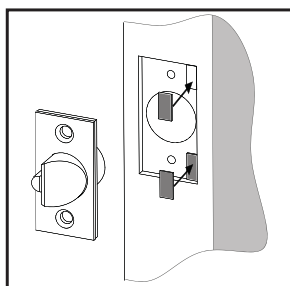

Figure 3

## Measure Frame Twist

One way to measure frame twist is to place a carpenter square on the stop and the face of the door. If the angle is less than 90 degrees, the 45 degree ramp angle of the 8000/8300 is steepened and may need to be corrected as shown at right (*Figure 1*).

We recommend you check the condition of the latch bolt prior to installing the 8000/8300. Poorly constructed, worn out or damaged latch bolts may not slide along a ramp at any angle. To check the condition of your latch bolt, we recommend applying a slight force to the tip of the latch bolt (about 45 degrees to the door face). Make sure the latch bolt can be pushed up into the door.

## Compensate for Frame Twist

When a frame is twisted, the relationship between the face of a closed door and of the inside face of the frame (i.e., Rabbet) may not meet the 90 degree industry standard. Untrue frames and doors impact latch bolt wear and the force required to exit, so we recommend you ensure that the angle is between 90–95 degrees.

If manipulating the frame is not possible, we recommend placing several shims under the top and bottom (stop side) of the faceplate (*Figure 2*). This effectively increases the 8000/8300 ramp angle and compensates for frame twist. You can also compensate for frame twist by placing shims under the top and bottom (bevel side) of the latchbolt (*Figure 3*).