

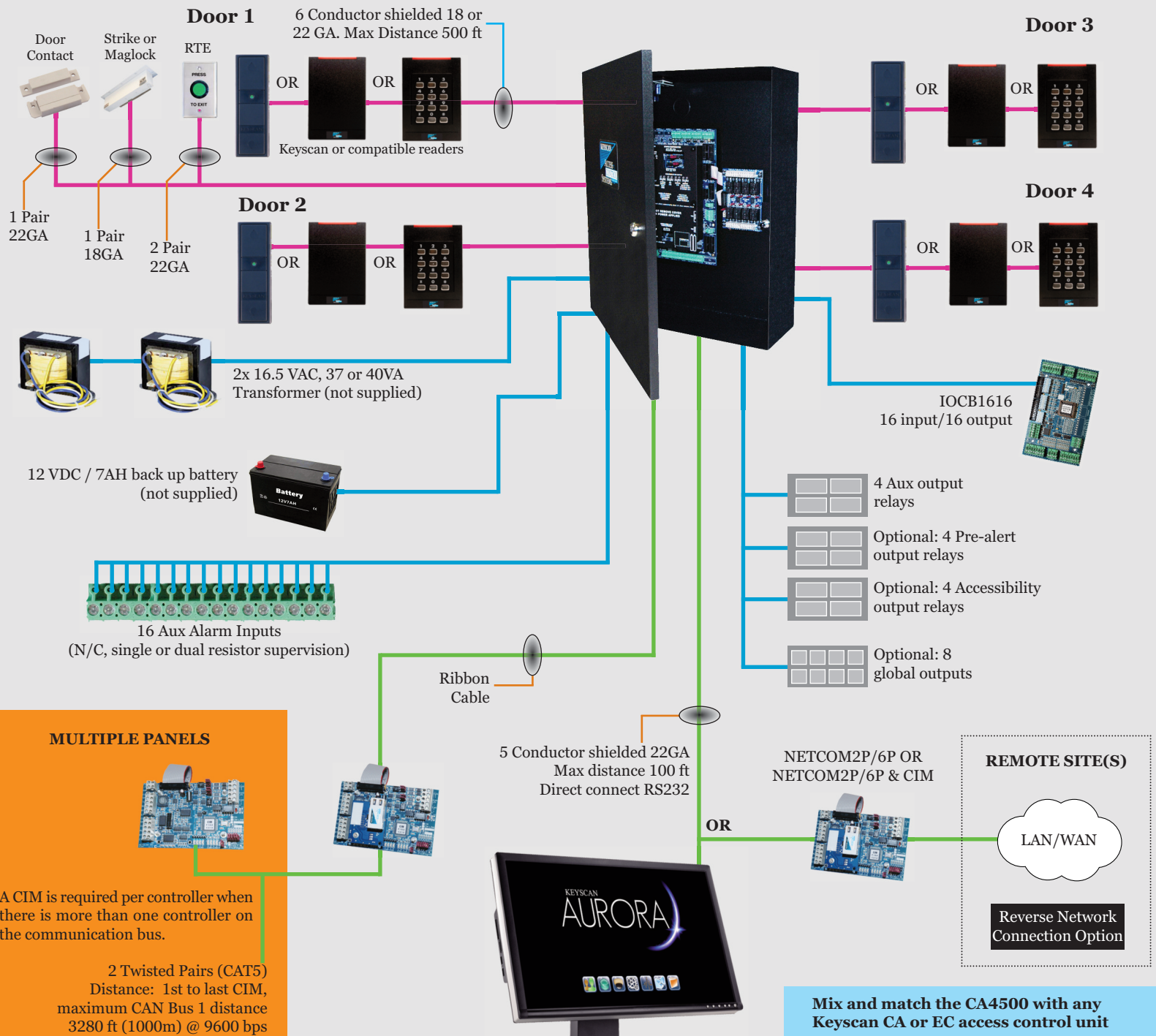





Keyscan[®] CA4500

4-Reader Access Control Unit



CA4500

4-Reader Access Control Unit

	CA150	CA250	CA4500	CA8500	EC1500	EC2500
Access Control Unit						
Doors/Elevator Floors Supported	1 door	2 doors	4 doors	8 doors	1 cab (40 floors)	2 cabs (16 floors)
Reader Ports	2 (in/out)	2	4	8	1	2
Multi ACU Compatibility	Yes (Ethernet)	Yes	Yes	Yes	Yes	Yes
System Status LEDs	Yes	Yes	Yes	Yes	Yes	Yes
Dual Processors	Yes	Yes	Yes	Yes	Yes	Yes
Flash Memory	Yes	Yes	Yes	Yes	Yes	Yes
Power Fail Output	NA	Yes	Yes	Yes	Yes	Yes
Floor Monitor Inputs (Supervised)	NA	NA	NA	NA	Yes	Yes
Inputs						
Request to Exit (RTE) Inputs (Supervised)	1	2	4	8	NA	NA
Door Contact Inputs	1	2	4	8	NA	NA
Auxiliary Inputs (Supervised)	2	8	16	16	NA	NA
I/O Input Expansion	NA	NA	64	64	NA	NA
Outputs						
Auxiliary Output Relays	1	2	4	8	NA	NA
Expansion Auxiliary Output Relays	NA	NA	8	8	NA	NA
I/O Outputs	NA	NA	64	64	NA	NA
Door Output Relays	1	2	4	8	NA	NA
Capacity						
No. of Credential-holders	45,000 (90,000*)	45,000 (90,000*)	45,000 (90,000*)	45,000 (90,000*)	45,000 (90,000*)	45,000 (90,000*)
Transaction File Buffer	6000	6000	6000	6000	6000	6000
Time Zones	256	256	256	256	256	256
Time Schedules	512	512	512	512	512	512
Group Levels	511	511	511	511	511	511
Holiday Dates	64	64	64	64	64	64
Connectivity						
Ethernet Ready	Equipped	Optional	Optional	Optional	Optional	Optional
PoE - Power over Ethernet (IEEE 802.3af)	Equipped	NA	NA	NA	NA	NA
Global Integration	Network/Server Dependant	Capable (requires CIM)	Capable (requires CIM)	Capable (requires CIM)	Capable (requires CIM)	Capable (requires CIM)
CMAC Reverse IP	Equipped	Optional	Optional	Optional	Optional	Optional
Serial Communication	Yes	Yes	Yes	Yes	Yes	Yes

Kaba ADS Americas
901 Burns Street East, Whitby, Ontario, Canada
L1N 0E6

Toll Free: 1.888.539-7226
Tel: +1.905.430.7226
keyscan.ca | kaba-adsamericas.com

KEY 2015-01

© Kaba (2015). Information on this sheet is intended for general use only. *Hardware available by special order. Kaba reserves the right to alter designs and specifications without notice or obligation. Printed in Canada.