

RESOLUTION



RE929X Flex LTE Communicator

Flex LTE Communicator is an LTE cellular device that provides interactive services and home automation to existing security systems.

Features

- Connects panels to the LTE cellular network
- Provides interactive services without panel replacement
- 5 year warranty

Installation

1. Set up an account with your interactive services provider.
2. Mount the communicator to a wall using the mounting holes on the back plate.

- Do not mount inside of a metal can. The cellular antennas need to be in free air to communicate.
- Mount as high in the building as possible to optimize cellular strength.

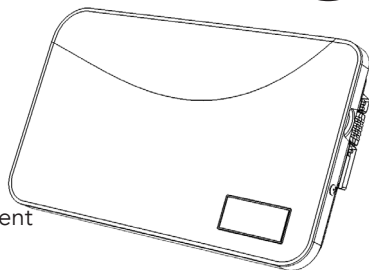

Mounting Screw Locations

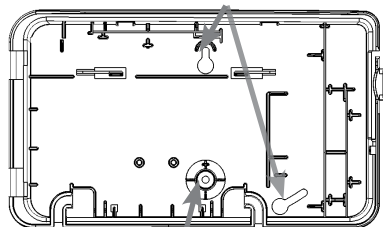

3. Program the panel to use the communicator. (Refer to the programming section for your panel.)
4. Wire the panel to the communicator. (Refer to the programming section for a wiring diagram for your panel.)

- The communicator power supply must have a battery backup.
- Maximum cable length to the panel:
 - 18 gauge wire = 350 feet
 - 22 gauge wire = 130 feet
 - 24 gauge wire = 75 feet

Note: Be sure to verify that all codes are being properly reported to the central station after you have installed the communicator module or modified any reporting program setting in the installer programming menu.

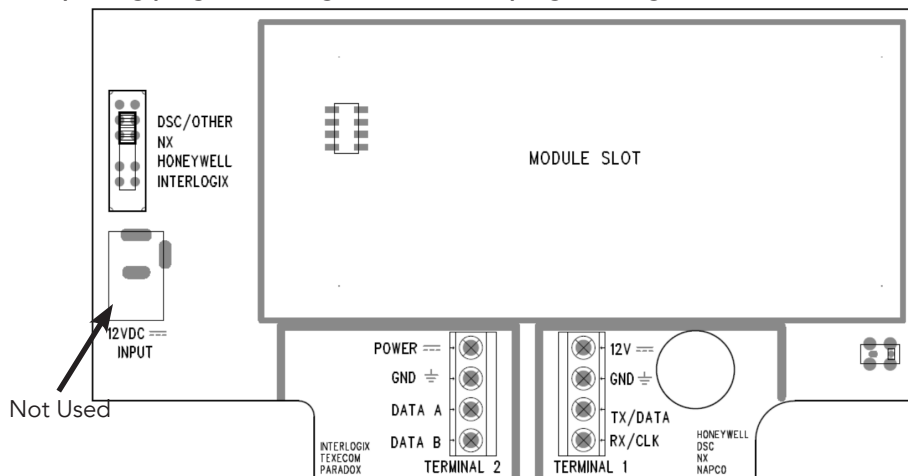

Verify proper enrollment and operation using your control panel's installation manual.

Honeywell® Vista™ 20P and Vista 15P, Vista 21IP Programming

Compatible Panels

- Vista 20P version 4.0 or later (controls only partition one)
- Vista 15P version 4.0 or later
- Vista 21P version 3.13 or later

1. Set up an account with your interactive services provider.
2. Add a contact that uses the system MASTER CODE to the account before connecting the communicator. This is required for the communicator to be able to properly configure the system settings.
3. Disarm the system (all partitions).
4. The communicator automatically talks with the Vista using AUI 2, which is usually enabled by default.

Enabling AUI 2 if not default:

- Enable AUI 2 in the *189 field.
 - If another device is using AUI 2, that device must first be moved to a different AUI address. The other device should be moved to AUI 1 for Vista 15P and AUI 1, 3, or 4 for Vista 20P.
5. Vista panels that have a *91 field that supports RIS need to have RIS disabled. No action is required if RIS is not supported.
 6. Use programming option *188 to disable keypad lockout.

Keypad lockout:

- Vista 15P and 20P panel versions 10.21 and later have the keypad lockout feature enabled by default and it is recommended this feature be disabled to prevent possible keypad lockout conditions if the system master code in the communicator is not synchronized with the master code in the Vista panel.
- If it is required to have the keypad lockout feature enabled, it is critical that the system master code be set up as a contact for this account before connecting the module to the panel (see step 2 above). Also, all changes to the system master code must be done at the user portal or dealer portal, not at the keypad. Failing to do this may result in a keypad lockout condition.

7. Power down the Vista system.
8. Set communicator's panel selector switch to **HONEYWELL**.
9. Connect the Vista system and communicator as shown in the wiring diagram below. Note: For Vista 21IP panels, Internal IP/GSM jumper needs to be set to "OFF".
10. Power up the Vista system and the communicator will automatically program it. Make sure all partitions are disarmed

- The Vista system will be busy for 50-60 seconds after power up before it will automatically program.
- Communicator will enable the following settings automatically:
 - * IP/GSM device (*29) = 1 (enabled)
 - * Communicate to IP/GSM device first (*55) = 1 (IP/GSM first)
 - * Opening report (*65) = 1 (enabled)
 - * Closing report (*66) = 1, 1 (stay closing and away closing reports enabled)
 - * Alarm cancel report (*68) = 1 (enabled)
 - * AC power restoral report (*73) = 1 (enabled)
 - * Low Battery restoral report (*74) = 1 (enabled),
 - * Phone Monitor (*92) = 0 (disabled)

11. Once the keypad(s) displays **DISARMED Ready to Arm**, installation is complete.

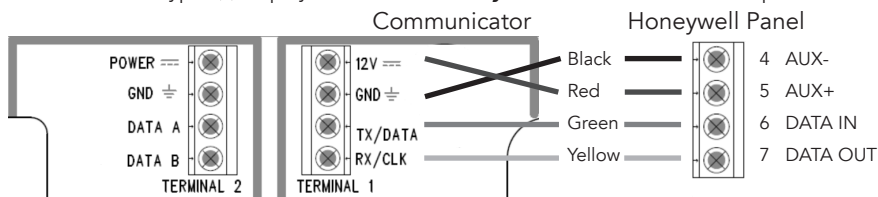

Compatible Panels

- PC580 (Power 432)
- PC5010 (Power 832)
- PC1616
- PC1555 (Power 632)
- PC5020 (Power 864)
- PC1832
- PC1555MX (Power 632)
- PC5015 (Power 832)
- PC1864

1. Set up an account with your interactive services provider.
2. Add a contact that uses the system MASTER CODE to the account before connecting the communicator. This is required for the communicator to be able to properly configure the system settings.
3. Program the DSC panel using an **INSTALLER CODE**.

Panel Programming

- Disable the Communicator ([380]:[1])
 - Disable the Telephone Line Monitor ([015]:[7])
 - Delete Telephone Numbers (programming section 301-303)
 - Verify Alt Comm ([351]:[5]) is enabled
 - Verify T-Link is Disabled ([382]:[5])
 - Verify Master Code Not Changeable is Disabled ([015]:[6])
 - Verify Access Code Required for *1, *2, *3 menus is disabled ([022]:[1])
 - Verify that keypad lockout is either zero (disabled) or higher than 6 ([012])
 - If you have removed any bus devices, perform a Module Supervision Reset ([902])
4. Verify alarm report codes are setup properly for zones that are being used, 1-64 (programming section 320-349). System will report as Burg (130) if programmed as FF.
 5. If using Aux input (PGM2) verify Aux input report codes are setup properly (programming section 329:4). System will report as Fire (110) if programmed as FF.
 6. To enable reporting of the Period Test Transmission, program the "Periodic Test Transmission" ([348]:[4]) and the "Periodic Test Transmission with Trouble" ([348]:[3]) reporting codes to "02".
 7. All other reports are hard coded in the communicator and cannot be changed regardless of what is entered in the programmed location.

- Format and account number have no effect on reporting.

8. Disarm the system (all partitions).
9. Power down the DSC system.
10. Set communicator's panel selector switch to **DSC/OTHER**.
11. Connect the DSC system and the communicator as shown in the wiring diagram below.
12. Power up to the DSC system.

- The DSC control panel will begin automatic configuration. This can take up to 2 minutes.

13. Installation is complete.

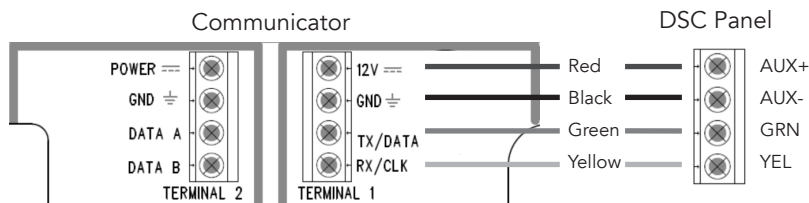

DSC Panel Reporting Codes

Event	Report Code
AC Fail/Restore	301
Panel Low Battery/Low Battery Restore	302
Opening/Closing Report	400
Cancel Report	406
Zone Alarm	See below
Keypad Fire Panic	110
Keypad Aux Panic	100
Keypad Police Panic	120
Duress	121
Periodic Test Transmission	602
Periodic Test With Trouble Transmission	608

Table of all events reported by the communicator when connected to a DSC panel.

Zone Alarm Reporting

- Automatic Contact ID is not supported.
- Manually programmed reporting codes are only supported for alarms on zones 1-64 ([320] - [324]) and for alarms on the PGM2/Aux input ([329] option 4) which is reported as zone number 99.
- If Report Codes have not been manually programmed for zone alarms, zone alarm reporting codes default to the following.
 - * Any zone alarm (zones 1-64): Code 1130 (Burglary)
 - * PGM2/Aux input (zone 99, likely a 2-wire Smoke): Code 1110 (Fire)

Caddx® NX™ Programming

Compatible Panels

- All NX series panels

1. Set up an account with your interactive services provider.
2. Add a contact that uses the system MASTER CODE to the account before connecting the communicator. This is required for the communicator to be able to properly configure the system settings.
3. Disarm the system (all partitions).
4. Power down the NX system.
5. Set the communicator's panel selector switch to **NX**.
6. Connect the NX panel and the communicator as shown in the wiring diagram.
7. Power up the NX system and the communicator will automatically program it.

- Communicator will enable the following settings automatically:
 - * Enable opening and closing reports
 - * Set telephone line cut delay to 0 (No TLM)

8. Installation is complete. Wait until the CS and platform LEDS have stopped blinking before entering program mode.

Additional Notes for NX Installations

- Some NX panels limit the number of non-keypad devices that are supported. Be sure that the panel you are connecting the communicator to does not have more than the number of supported devices connected.
- User codes that are added to the system or edited thru the communicator will have the default or previous partitions enabled. If you desire the users to have different partitions enabled, you will need to modify the partitions thru the NX keypad.
- 6-digit access codes are not supported.

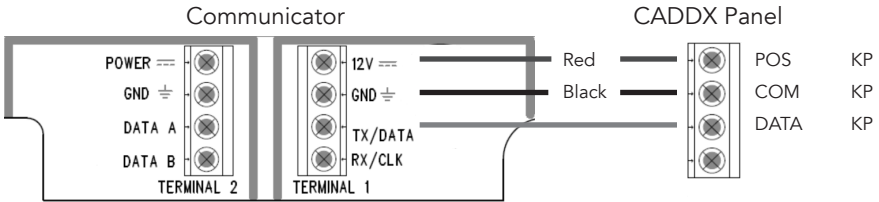

Interlogix® Concord™ Programming

Compatible Panels

- Concord 4

1. Set up an account with your interactive services provider.
2. Add a contact that uses the system MASTER CODE to the account before connecting the communicator. This is required for the communicator to be able to properly configure the system settings.
3. Disarm the system (all partitions).
4. Program the Concord panel using an **INSTALLER CODE**.

Panel Programming

- Turn off ACCESS CODE LOCK (0003)
 - Delete phone numbers for CS1-CS3 (01000-01020)
 - Turn on OPENING REPORTS for partition 1 (06100)
 - Turn on CLOSING REPORTS for partition 1 (06101)
5. If there is an automation or wireless reporting device (i.e. automation module, cell backup module) already connected to the panel, remove the device and delete it from the panel. Concord 4 only supports 1 automation bus device.
 6. Power down the Concord system.
 7. Set the communicator's panel selector switch to **INTERLOGIX**.
 8. Connect the Concord panel and the communicator as shown in the wiring diagram.
 9. Power up the Concord system.

Concord programming if first time powered with a communicator

- Do not press any keys on the keypad for the first 2 minutes after power up.
 - After 2 minutes, initiate a bus scan (8 installer code+1).
 - Do not press any keys on the keypad for 1 minute after you have performed the bus scan.
10. Installation is complete.

Additional Notes for Concord Installations

- Be sure to turn off **ACCESS CODE LOCK** before adding the communicator.
- If the CS or Platform LED is still blinking, refer to "Trouble Shooting the Panel Connection".
- It is normal for the keypad to display "Enter Light Key" a few times after connecting the communicator to the panel. If the keypad continues to display "Enter Light Key", verify you have the correct system master code setup in the account.

Interlogix Panel

Communicator

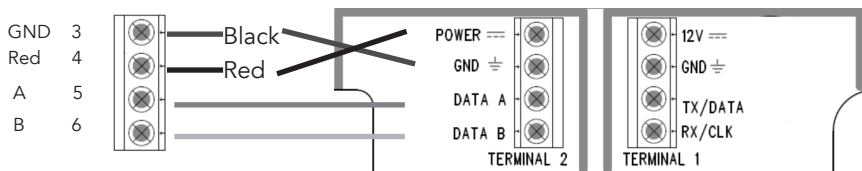

Paradox Programming

Compatible Panels

- Paradox MG5050

1. Set up an account with your interactive services provider
2. Enter System Programming Menu on panel using Dealer Code (Default Code=0000).
3. Enter "System Setup" under the "Menu" Tab
4. Enter "Advanced" under the "Installer Programming" menu
5. Select "System Programming" under the "Advanced Programming" tab
6. Enter Section [911] under "System Programming"
7. Enter a PC Password (Ex. 9999) and hit 'Next'
 - Used for authentication so IGM can communicate with the panel
 - This code will be entered into the dealer portal later
 - Do not use the same code as the master code
8. Exit to main page by pressing the home icon in the top left corner of the screen
9. Power the system down
10. Set IGM slider switch to DSC/Other
11. Plug IGM into the serial connector via IGM-Paradox cable (sold separately)
12. Power the system up
13. From the Dealer Portal of your service provider, select "Contacts" tab and Edit master user
14. Add the panel's master code for User ID: Master (Default master code is 1234)
15. Enable master authority level for this master user
16. Select "Users" tab
17. Add User ID: Password using PC Password code entered earlier (Ex. 9999)

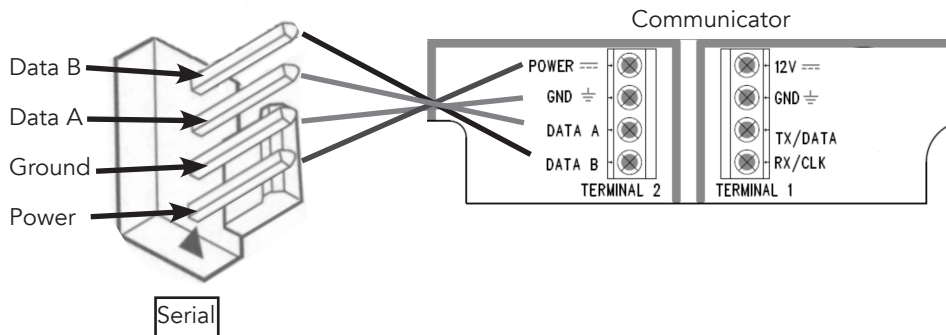

Napco® GEM™ Programming

Compatible Panels

- GEM P816
- GEM P1632

1. Set up an account with your interactive services provider.
2. Add a contact that uses the system DEALER CODE to the account before connecting the communicator. This is required for the communicator to be able to properly configure the system settings.
3. Disarm the system.
4. Program the Napco system using a **DEALER CODE**.

Panel Programming

- Add an additional keypad.
- Program zone reporting codes.
 - * Version 29 and older uses locations 0358-0373.
 - * Version 30 and newer uses locations 0720-0735.
 - * The communicator uses the left digit of the data entry to generate reporting codes for each zone
- Verify the DEALER CODE entered on the online portal matches the code in the panel.
- This step is only required on **PANEL VERSION 30 OR NEWER**.
 - * Disable "Enable Keypad 1 Only Programming." (Location 2053, bit 7)

5. Exit dealer programming,
6. This step is only required on **PANEL VERSION 29 OR OLDER**. Move keypad 1 to a different keypad address as this will allow the communicator to program the Napco panel.

Steps to Move Keypad 1 to a Different Keypad Address

- Power down the Napco system.
- Find the mode jumper located on the Napco panel board.
- Move the mode jumper to the **CONFIG** state.
- Power up the Napco system.
- The display should show **01 OUT OF SYSTEM**.
- Press **1 1 1 2 3 + FUNCTION**.
- Cycle through the menu until you see **Keypad Address**.
- Change the keypad address to an open keypad location.
- Press enter or on/off to save the entry.
- Power down system and move the mode jumper back to **NORM**.

7. Set communicator panel selector switch to **DSC/OTHER**.
8. Connect the Napco system and communicator as shown in the wiring diagram. Be sure to add a jumper wire between TX and RX, as shown in the wiring diagram below.
9. Power up the Napco system and the communicator will automatically program it. Make sure all partitions are disarmed.

- Programming starts as soon as a connection is made to the interactive server. Once the connection is made programming will last roughly 3 minutes.
- Communicator will read the following data fields. Access Codes, Reporting Codes, Enable Global Ambush Code, Global Ambush Code
- Communicator will change the following data fields. CS Receiver 1 Format (C "Ademco Point ID")

10. The keypad(s) should display **SYSTEM READY**.
11. Installation is complete.

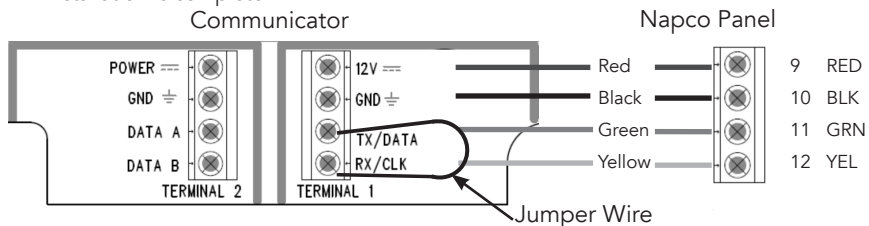

Napco GEM Programming

Compatible Panels

- GEM P800
- GEM P801

1. Set up an account with your interactive service provider.
2. Add a contact that uses the system DEALER CODE to the account before connecting the communicator. This is required for the communicator to be able to properly configure the system settings.
3. Disarm the system.
4. Program the Napco system using a **DEALER CODE**.

Panel Programming

- Program zone reporting codes. Programming location 61.
- Note: The following zone types will be treated as 24-hour zones: (1) Fire, (2) Panic, (4) Hold- Up (7) Gas Alarm, (8) Heat Alarm, (B) 24-hour alarm
- Verify the **Dealer Code** entered on the online portal matches the code in the panel.
- Disable telco reporting for zones 1-8.

5. Exit dealer programming.
6. Power down the panel
7. Set the communicator panel selector switch to **DSC/OTHER**.
8. Power up the Napco panel. The communicator will automatically program it. make sure all partitions are disarmed and dealer programming has been exited.
 - Programming starts as soon as a connection is made to the interactive server. Once the connection is made programming will last roughly 1 minute.
 - Communicator will read Access Code 1, Reporting Code Configuration.
9. The keypad(s) should display **SYSTEM READY**.
10. Installation is complete.

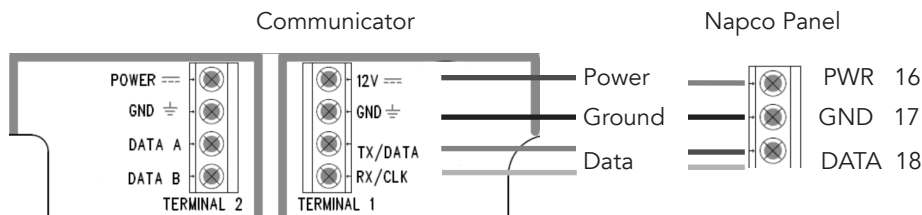

Texecom Programming

Not yet supported, coming soon.

Operation

Events are reported to both the monitoring receiver and the interactive server. All events use Contact ID reporting codes.

Events reported by default

- Alarms
- Alarm cancels
- Openings
- Closings
- System Low Battery
- System Low Battery Restoral
- AC Power Fail (delayed by some panels)
- AC Power Restoral (delayed by some panels)

Honeywell Vista panels can enable additional event reporting by using system programming.

Remote control of the system can be done through the interactive services platform.

Arming/Disarm control and status apply only to partition 1.

Z-Wave devices can be controlled using the interactive services platform.

Factory default button will reset the communicator if held for 5 seconds, and if held for approximately 10 seconds will factory default the communicator.

- LED flashes twice when the communicator is factory defaulted.

Cellular LED indicators

LED	Indication
Power (Green)	Flashing off once every second - Primary Mode Flashing off once every three seconds - Backup Mode
Cellular (Red)	ON - Registered with the local cellular network
CS (Red)	ON - Connected to central station Blinking - Problem detecting panel type
Platform (Yellow)	ON - Connected to panel and interactive server Blinking - Problem communicating to the panel

Cellular signal bar LEDs indicate the quality of the cellular connection. A minimum of two signal bar LEDs is recommended.

Number of Signal Bar LEDs Lit	Cellular Signal Strength
0	Bad (0 to 14)
1	Marginal (15 to 19)
2	Acceptable (20 to 24)
3	Good (25 to 30)
4	Best (30+)

Troubleshooting

Symptom	Troubleshooting Steps
<p>Platform LED Blinking</p>	<p>General</p> <ol style="list-style-type: none"> 1. Incorrect wiring 2. Incorrect panel switch position 3. Unsupported panel version 4. Unsupported panel model 5. Panel is in Installer Program Mode <p>Honeywell Vista</p> <ol style="list-style-type: none"> 1. AUI not enabled 2. AUI used for some other function 3. LRR not enabled 4. Another LRR or IP/GSM device connected to panel bus <p>Interlogix Concord 4</p> <ol style="list-style-type: none"> 1. Module not enrolled into the Concord Bus (perform another bus scan) 2. Another Automation device is enrolled on the Concord Bus <p>NX</p> <p>1. Some NX panels limit the number of non-keypad devices they support. Be sure that the panel you are connecting the communicator to does not have more than the number of support devices connected. (i.e. some NX-4 panels only support 1 module in addition to keypads so they cannot support both an IGM and a wireless receiver.</p>

Symptom	Troubleshooting Steps
<p>CS Light Blinking</p>	<ol style="list-style-type: none"> 1. Verify the panel selection switch location 2. Verify wiring 3. Verify the panel is supported by the gateway (both panel type and version)
<p>CS Light Off</p>	<p>Ensure an account has been created and activate at the central station or monitoring station.</p> <p>If registration information changes after the IGM is powered up, perform a factory default.</p>
<p>Both Lights Off</p>	<p>Ensure an account has been created and that it is active/Live.</p> <p>If registration information changes after the IGM is powered up, perform a factory default.</p>
<p>Supervisory Trouble Information</p>	<p>Honeywell- LRR Fault/bF error - Verify panel is 4.0 or later.</p>

Troubleshooting

Cellular communication problems can be solved in many ways:

- Make sure antennas are securely snapped into the circuit board
- Reposition the unit (move or rotate)
- Move the unit higher in the building
- Move the unit away from metal objects (appliances, ducts)
- Move the unit closer to a window
- Move to one of the below higher performance antenna options

Antenna Options

Internal antenna - RE038

Good Performance

Offers a compact solution

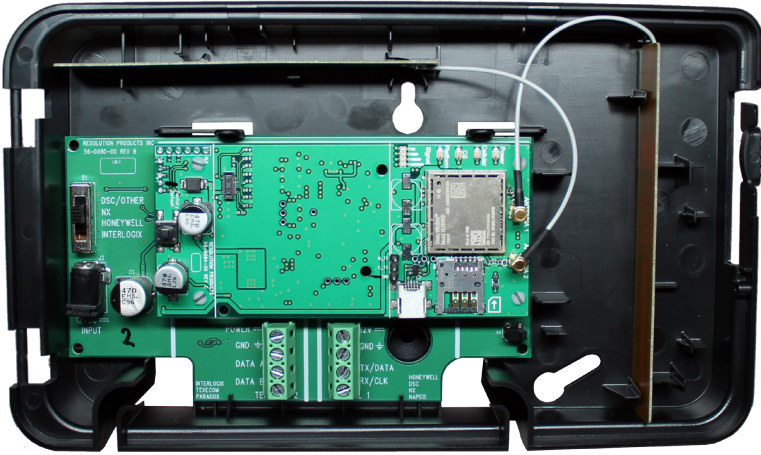

Wall drop antenna - RE036 and RE036-0

Better performance

Antenna can be hidden in the wall

Cellular performance is improved by replacing just antenna 1 although both antennas can be wall drop antennas.



Side mount antenna - RE039

Best performance

Offers optimal cellular performance

Cellular performance can be improved by replacing just antenna 1 although both antennas can be side mount antennas.



- Pull up gently on the antenna's connector to release it from the cellular module.

This Page Intentionally Left Blank

Specifications

Physical	
Housing Dimensions	8.5 x 5.0 x 1.3 inches
Weight	10.0 ounces
Mounting Fastener	#4 or #6 (not provided)
Reported Indications	Cover Tamper, Wall Tamper
Current Draw	200mA (Nominal)
Environmental	
Operating Temperature	32°F to 120°F
Maximum Humidity	85% non-condensing relative humidity
Panel Compatibility	
Honeywell DSC	Vista 15P, Vista 20P PC580 (Power 432), PC1555 (Power 632) , PC1555MX (Power 632), PC5010 (Power 832), C5020 (Power 864) , PC5015 (Power 832), PC1616, PC1832, PC1864
Caddx	All NX series panels
Interlogix	Concord 4
Napco	GEM P800, GEM P801, GEM P816 GEM P1632
Paradox	MG5050
Texecom	None yet
Models	
RE929X-00-01	Flex LTE Communicator
RE929X-01-01	Flex LTE Communicator with Zwave
Certification	
RE929X	FCC, Verizon

Specifications subject to change without notice

WARRANTY

Resolution Products, Inc. will replace non-portable products that are defective in their first five (5) years and portable products that are defective in their first two (2) years.

FCC NOTICE

This device complies with Part 15 of the FCC rules. Operation is subject to the following two conditions:

- (1) This device may not cause harmful interference.
- (2) This device must accept any interference that may be received, including interference that may cause undesired operation.

Changes or modifications not expressly approved by the Resolution Products, Inc. could void the user's authority to operate this equipment.

RF Exposure:

To satisfy FCC RF Exposure requirements for mobile and base station transmission devices, a separation distance of 20 cm or more should be maintained between the antenna of this device and persons during operation. To ensure compliance, operation at closer than this distance is not recommended.

TRADEMARKS

"GE", "INTERLOGIX", "HONEYWELL", "DSC", "2GIG", "QOLSYS" AND, "NAPCO" ARE TRADEMARKS OWNED BY GENERAL ELECTRIC COMPANY, UNITED TECHNOLOGIES ELECTRONIC CONTROLS INC., HONEYWELL INTERNATIONAL INC., TYCO SAFETY PRODUCTS CANADA LTD, NORTEK SECURITY & CONTROL LLC, TYCO SAFETY PRODUCTS CANADA LTD, NAPCO SECURITY TECHNOLOGIES, INC., AND RESPECTIVELY.

RESOLUTION PRODUCTS, INC. PRODUCTS WILL FUNCTION WITH ONE OF EITHER INTERLOGIX (FORMERLY GE), HONEYWELL, DSC, 2GIG , QOLSYS OR NAPCO SYSTEMS. HOWEVER, NO RESOLUTION PRODUCT IS PRODUCED BY, ENDORSED BY, NOR IS OFFICIALLY ASSOCIATED WITH INTERLOGIX (FORMERLY GE), HONEYWELL, DSC, 2GIG, QOLSYS OR NAPCO. RESOLUTION RECOMMENDS VERIFYING PROPER ENROLLMENT AND OPERATION, PER CONTROL PANEL INSTALLATION INSTRUCTIONS, AT INSTALLATION.