

## LED Strobe Lights

### SL-1301-EAQ

12 LEDs total, flash only

### SL-1301-BAQ

32 LEDs total, 5 LED strips

Same as EAQ series plus adjustable flash speeds and patterns, and optional battery backup

### SL-1301-SAQ

54 LEDs total, 10 LED strips

Same as BAQ series plus 100dB siren



### Features:

- Utilizes high-intensity LEDs
- Operating life over 50,000 hours (over 5.7 years)
- Same size as the SL-126Q strobe light
- Simple 2-wire installation
- Weather resistant
- High-impact resistant case
- High-impact and heat-resistant lens
- Reverse polarity protection
- Visible in all directions
- 5 lens colors available:  
Amber, Blue, Clear, Green and Red



### Ordering Info:

Model	12 LED	32 LED	54 LED
<b>Amber</b>	SL-1301-EAQ/A	SL-1301-BAQ/A	SL-1301-SAQ/A
<b>Blue</b>	SL-1301-EAQ/B	SL-1301-BAQ/B	SL-1301-SAQ/B
<b>Clear</b>	SL-1301-EAQ/C	SL-1301-BAQ/C	SL-1301-SAQ/C
<b>Green</b>	SL-1301-EAQ/G	SL-1301-BAQ/G	SL-1301-SAQ/G
<b>Red</b>	SL-1301-EAQ/R	SL-1301-BAQ/R	SL-1301-SAQ/R

### BAQ series also include all features of the EAQ plus:

- 5 Vertical LED strips (32 LEDs total) increase visibility from various directions
- 6 different flashing options
- Adjustable flashing speed
- Backup battery available for continuous lighting applications

### SAQ series also includes all features of the BAQ plus:

- 10 Vertical LED strips (54 LEDs total)
- Built-in 100dB siren (programmable)

### Specifications:

Model	SL-1301-EAQ	SL-1301-BAQ	SL-1301-SAQ
<b>Operating voltage</b>	6~12 VDC	9~12VDC, 12 VAC	10~24 VAC/VDC
<b>Current draw (max)<sup>1</sup></b>	200mA	30~180mA	90~350mA
<b># of flash patterns<sup>2</sup></b>	1	6	6
<b>Flashing speed</b>	130 times/min	Adjustable 30~260 times/min	
<b>Vertical LED strips</b>	0	5	10
<b>Total # of LEDs</b>	12	32	54
<b>Backup battery<sup>3</sup></b>	No	Yes	Yes
<b>Operating temperature</b>	-4°~144° F (-20°~65° C)		
<b>Electrical protection</b>	Reverse polarity protected		
<b>Built-in siren</b>	No	Yes (100dB)	
<b>IP rating</b>	IP66		IP55
<b>Dimensions</b>	3 <sup>15</sup> / <sub>16</sub> "x2 <sup>29</sup> / <sub>32</sub> " (100x74mm)		

<sup>1</sup>Depending on settings

<sup>2</sup>SL-1301-EAQ series has strobe only

<sup>3</sup>9VDC battery not included

### SECO-LARM® U.S.A., Inc.

16842 Millikan Avenue, Irvine, CA, 92606

Phone: (949) 261-2999 | (800) 662-0800 Fax: (949) 261-7326

Website: www.seco-larm.com Email: sales@seco-larm.com











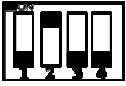
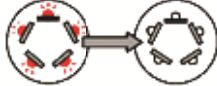
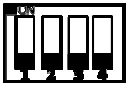

Copyright 2015 © SECO-LARM U.S.A., Inc. All rights reserved.

The SECO-LARM policy is one of continual development. For that reason, SECO-LARM reserves the right to change prices and specifications without notice. SECO-LARM is not responsible for misprints.

SECO-LARM® ENFORCER® CRIMEBUSTER® CBA SLI®

Pi\_SL-1301-xAQ\_150706.docx

## Programmable Flashing Patterns (BAQ & SAQ models only):

DIP Switch Position	Flash Pattern Description (SL-1301-BAQ shown)	
1 	<b>Strobe</b> LEDs flash on and off continuously. (Default setting)	
2 	<b>Rotate Clockwise</b> Light rotates clockwise in a circular fashion continuously. (Beacon)	
3 	<b>Steady ON</b> All LEDs stay on. Ideal for continuous lighting applications.	
4 	<b>Flash with Progressive ON</b> LEDs turn on progressively clockwise until all LEDs are lit (sweep), and then turn off.	
5 	<b>Rotate Back and Forth</b> LED groups light up one at a time, rotating clockwise and counterclockwise.	
6 	<b>Flash with Progressive ON/OFF</b> LEDs turn on progressively clockwise (sweep), then turn off progressively counterclockwise.	

## Dimensions:

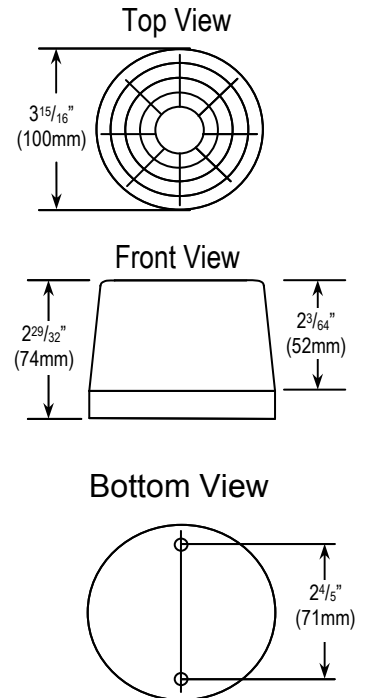

## Also Available from SECO-LARM:

*Note: The SL-1301 series LED strobe light has the same dimensions as the SL-126 series strobe light.*

Replacement Lenses  
SL-126LQ/X  
(Replace "X" with the first letter of the desired color)



Available in Red, Blue, Amber, Clear, or Green

### Mounting Options

Conduit Drop  
SL-1901-DAQ



Conduit Box  
SL-1901-JAQ



### Application Photos

Conduit Drop



Conduit Box



Both



Xenon Tube Strobe Lights  
SL-126Q Series



Available in Red, Blue, Amber, Clear, or Green

**SECO-LARM® U.S.A., Inc.**

16842 Millikan Avenue, Irvine, CA, 92606

Phone: (949) 261-2999 | (800) 662-0800 Fax: (949) 261-7326

Website: www.seco-larm.com Email: sales@seco-larm.com

Copyright 2015 © SECO-LARM U.S.A., Inc. All rights reserved.

The SECO-LARM policy is one of continual development. For that reason, SECO-LARM reserves the right to change prices and specifications without notice. SECO-LARM is not responsible for misprints.

**SECO-LARM® ENFORCER® CRIMEBUSTER® CBA SLI®**

Pi\_SL-1301-xAQ\_150706.docx

