



Southwire™

TOOLS & EQUIPMENT

1-855-SWTOOLS
TOLL FREE TECHNICAL HELP
Línea de Ayuda Técnica Gratuita

Contents Made in China/Fabriqué en Chine
Product distributed by/Produit distribué par
Southwire Company, LLC.
One Southwire Drive, Carrollton, GA 30119
©2016 Southwire Company, LLC.
All rights reserved. Tous droits réservés.

10031S manual/manual



Southwire™

TOOLS & EQUIPMENT

Operating Instructions 10031S Manual Ranging Digital Multimeter

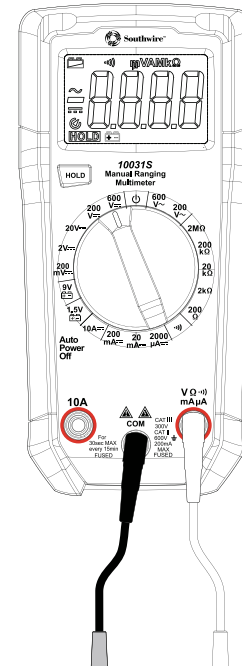

Introduction

The Southwire 10031S multimeter measures AC and DC voltage, DC current, and resistance. It also tests continuity and 1.5V and 9V batteries. Other features include a large LCD display, display HOLD, and Auto Power Off. Flip the meter over and on the back side there are several features to make your life easier such as test lead storage, an integrated kickstand, and the ability to add a Southwire magnetic hanging strap (Model# 60151R).

Your Southwire 10031S multimeter is fully tested and calibrated. With proper use, it will provide many years of reliable service.

⚠ WARNINGS

- Read, understand and follow the Safety Rules and Operating Instructions in this manual before using this meter.
- The meter's safety features may not protect the user if not used in accordance to the manufacturer's instructions.
- Ensure that the test leads are fully seated in the input jacks and keep fingers behind the finger guards when taking measurements.

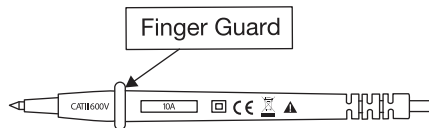

- Before changing functions using the rotary function switch, always disconnect the test leads from the circuit under test.
- Use only UL listed test leads with the proper safety category rating.
- Comply with all safety codes. Use approved personal protective equipment when working near live electrical circuits - particularly with regard to arc-flash potential.
- Use caution on live circuits. Voltages above 30VAC RMS, 42VAC peak, or 60VDC pose a shock hazard.
- Do not use meter or test leads if they appear damaged.
- Do not use the meter if it operates incorrectly. Protection may be compromised.
- Verify operation before using meter by measuring a known live voltage.
- Do not use the meter in wet or damp environments or during electrical storms.
- Do not use the meter near explosive vapors, dust or gasses.
- Do not operate meter while Low Battery warning is on. Replace the battery immediately.
- Do not apply voltage or current that exceeds the meter's maximum rated input limit.





Input Limits

Function	Maximum Input
Voltage AC or DC	600VAC RMS / 600VDC
μ A/mA DC Current	0.5A fast acting fuse 660V AC/DC
10A DC Current	10A fast acting fuse 600V AC/DC (<5A, 30 seconds max every 15 minutes, >5A, 10 seconds max every 15 minutes)
Resistance/Continuity	600VAC RMS/600VDC
Battery Test	600V AC/DC

General Specifications

Insulation	Class 2, Double insulation.
Display	2000 count LCD display
Polarity	Automatic. Minus symbol “-“ is displayed for negative polarity
Over Range Indication	“OL” is displayed
Continuity	Audible signal will sound if the resistance is approximately 30 Ω or less
Battery Test Current	1.5V battery test approximately 29mA. 9V battery test approximately 6mA
Low Battery Indication	“  ” is displayed if battery voltage is too low for normal operation
Measurement Rate	3 times per second, nominal
Auto Power Off	Meter automatically turns off after approximately 15 minutes of inactivity
Input Impedance	≥ 10MΩ AC/DC Voltage
AC Response	Average responding
AC Voltage Bandwidth	45Hz to 400Hz
Power Source (Battery)	One 9V battery (NEDA 1604)
Fuses	Fuse 10A/600V, Φ6.3 x 25, Fuse 0.5A/660V Φ6.3 x 32
Operating Temperature	32°F to 122°F (0°C to 50°C)
Storage Temperature	14°F to 122°F (-10°C to 50°C)
Relative Humidity	Maximum, non-condensing: 95% to 82°F (28°C), 75% to 104°F (40°C), 45% to 122°F (50°C)
Operating Altitude	7000 feet maximum (2133 meters maximum)
Weight	0.55 pounds (249 grams) includes 9V battery
Size	6.0" x 2.9" x 2.0" (152 x 74 x 51mm)
Safety	UL: 61010 - 1:2012, 61010-2-030: 2012, 61010-2-033: 2014 EMC: EN61326-1:2013, EN61326-2-2:2013

International Safety Symbols

	Potential danger. Indicates the user must refer to the manual for important safety information.
	Indicates hazardous voltages may be present
	Equipment is protected by double or reinforced insulation.
	Indicates the terminal(s) so marked must not be connected to a circuit where the voltage with respect to earth ground exceeds the maximum safety rating of the meter.
	Indicates the terminal(s) so marked may be subjected to hazardous voltages.

Safety Category Ratings

Category Rating	Brief Description	Typical Applications
CAT II	Single phase receptacles and connected loads	<ul style="list-style-type: none"> - Household appliances, power tools - Outlets more than 30ft (10m) from a CAT III source - Outlets more than 60ft (20m) from a CAT IV source
CAT III	Three phase circuits and single phase lighting circuits in commercial buildings	<ul style="list-style-type: none"> - Equipment in fixed installations such as 3-phase motors, switchgear and distribution panels - Lighting circuits in commercial buildings - Feeder lines in industrial plants - Any device or branch circuit that is close to a CAT III source

The measurement category (CAT) rating and voltage rating is determined by a combination of the meter, test probes and any accessories connected to the meter and test probes. The combination rating is the LOWEST of any individual component.

⚠ WARNING: Operation is limited to CAT II applications when the insulated tips are **removed** from one or both test probes. Refer to Input Limits section of this manual for maximum voltage ratings.

General Specifications cont.

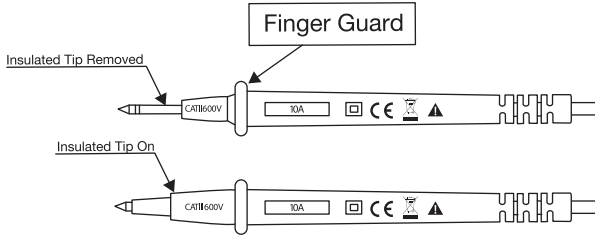

Maintenance

- This Multimeter is designed to provide years of dependable service if the following care instructions are performed:
- **KEEP THE METER DRY.** If it gets wet, wipe it off.
- **USE AND STORE THE METER IN NORMAL TEMPERATURES.** Temperature extremes can shorten the life of the electronic parts and distort or melt plastic parts.
- **HANDLE THE METER GENTLY AND CAREFULLY.** Dropping it can damage the electronic parts or the case.
- **KEEP THE METER CLEAN.** Wipe the case occasionally with a damp cloth. **DO NOT** use chemicals, cleaning solvents, or detergents.
- **USE ONLY FRESH BATTERIES OF THE RECOMMENDED SIZE AND TYPE.** Remove old or weak batteries so they do not leak and damage the unit.
- **IF THE METER IS TO BE STORED FOR A LONG PERIOD OF TIME,** the batteries should be removed to prevent damage to the unit.

Meter Description

FRONT VIEW

1. LCD display (see NOTE below)
2. HOLD button
3. Rotary function switch
4. 10A (positive) input jack. Plug the red test lead into this input jack when measuring current up to 10A
5. COM input jack. Plug the black test lead into this input jack.
6. $V/\Omega/\Pi$ /mA/ μ A. Plug the red test lead into this input jack when measuring voltage, resistance, continuity, and current up to 200mA

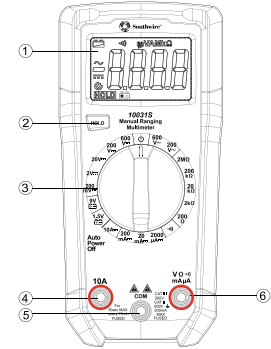

NOTE: Remove the protective plastic film from the LCD display before use.

REAR VIEW

7. Battery/Fuse Cover (shown below with integrated kickstand removed)
8. Test Lead Storage
9. Magnetic Hanging Strap bracket
10. 9V battery
11. Fuse 0.5A/660V Φ 1/4" x 1 1/4"
12. Fuse 10A/600V, Φ 1/4" x 1"

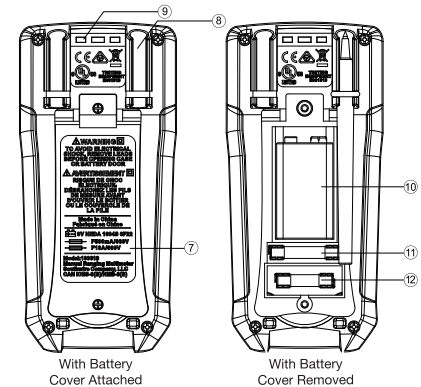

Symbols Used on LCD Display

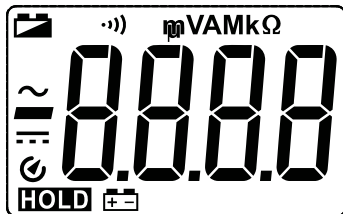

V	Volts
A	Amperes
~	AC Voltage or Current
≡	DC Voltage or Current
-	Minus Sign
OL	Overrange
Ω	Ohms
μ	micro (10^{-6})
m	milli (10^{-3})
k	kilo (10^3)
M	mega (10^6)
·)	Continuity
+	Battery Test
HOLD	Display Hold
☺	Auto Power Off
⚡	Low Battery Indicator

Auto Power Off ☺

To extend battery life, the multimeter will automatically turn off after 15 minutes of inactivity. The meter will beep 5 times after 14 minutes of inactivity to warn you that the meter is approaching Auto Power Off. After 15 minutes of inactivity, the meter will beep once and then turn off. To restore operation after the meter has been turned off, momentarily press the **HOLD** button.

Anytime you change the meter dial position or press the **HOLD** button, the APO timer will be reset to 15 minutes.

The Auto Power Off (APO) symbol ☺ is displayed on the LCD screen when the APO function is active.

HOLD Button

To freeze the reading on the LCD display, momentarily press the **HOLD** button. The “**HOLD**” indicator will appear on the LCD display. Momentarily press the **HOLD** button again to return to normal operation. The **HOLD** value will be lost if the position of the meter dial is changed or the meter is turned off.

Operation

AC Voltage Measurements

⚠ WARNING: Observe all safety precautions when working on live voltages.

1. Set the rotary function switch to the 600V~ position.
2. Insert the black test lead into the COM input jack and the red test lead into the V input jack.
3. Touch the test lead probes in parallel to the circuit under test.
4. Read the voltage on the display. If desired, turn the function switch to the 200V~ position to obtain a more precise reading. The display will indicate the proper decimal point and value.

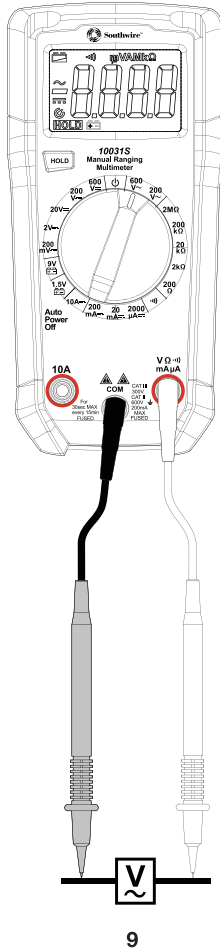

DC Voltage Measurements ---

⚠ WARNING: Observe all safety precautions when working on live voltages.

1. Set the rotary function switch to the 600V --- position.
2. Insert the black test lead into the **COM** input jack. Insert the red test lead into the V input jack.
3. Touch the black test probe to the negative side of the circuit. Touch the red test probe to the positive side of the circuit.
4. Read the voltage in the display. If desired, turn the function switch to successively lower V positions to obtain a more precise reading. If the black and red test probe tips are reversed, the polarity is reversed and the display will show a (-) minus sign in front of the reading.

DC Current Measurements

⚠ WARNING: Observe all safety precautions when working on live circuits. Do not measure current on circuits that exceed 600V. Measurements in the 10A range should be limited to 30 seconds maximum every 15 minutes when the current is under 5A and should be limited to 10 seconds maximum every 15 minutes when the current is equal to or greater than 5A.

1. Insert the black test lead into the **COM** input jack.
2. For current measurements up to 10A DC, set the rotary function switch to the **10A** range and insert the red test lead into the **10A** input jack.
3. For current measurements up to 200mA DC, set the rotary function switch to **200mA** range and insert the red test lead into the **mA** input jack.
4. Remove power from the circuit under test, then open up the circuit at the point where you wish to measure current.
5. Connect the black test probe tip to the negative side of the circuit. Connect the red test probe to the positive side of the circuit.
6. Apply power to the circuit.
7. Read the current in the display.
8. If desired when using the 200mA setting, turn the rotary function switch to successively lower positions (20mA, then 2000 μ A) to obtain a more precise reading. If the polarity is reversed, the display will show a (-) minus sign in front of the reading.

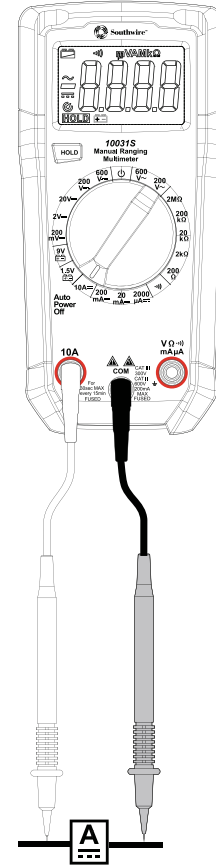

10A Measurements – Notice that the red test lead is plugged into the 10A input jack

Operation cont.

Resistance Measurements

⚠ WARNING: Never test resistance on a live circuit.

1. Set the rotary function switch to the highest Ω position.
2. Insert the black test lead into the **COM** input jack and insert the red test lead into the Ω input jack.
3. Touch the test lead probes across the circuit or component under test. It is best to disconnect one side of the device under test so the rest of the circuit will not interfere with the resistance reading.
4. Read the resistance on the LCD display. If desired, turn the rotary function switch to a lower Ω position (200k Ω , then 20k Ω , then 2k Ω , then 200 Ω) to obtain a more precise reading.

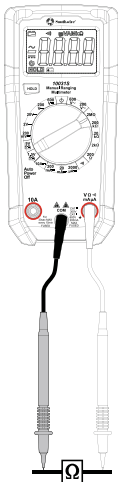

Operation cont.

Continuity Test

⚠ WARNING: Never test continuity on a live circuit.

A Continuity Test is used to verify if the path for an electrical circuit is continuous or unbroken. Only a closed or complete circuit has continuity. During a continuity test, the multimeter sends a small current through the circuit to measure resistance. The beeper will sound if the circuit is found to be continuous.

1. Set the rotary function switch to the $\cdot\Omega$ position.
2. Insert the black test lead into the **COM** input jack and insert the red test lead into the $\cdot\Omega$ input jack.
3. Touch the test lead probes to the component or wire you wish to check.
4. If the resistance is approximately 30 Ω or less, an audible signal will sound. If the resistance is above 220 Ω , the display will indicate "OL". The resistance will be shown on the display if it is below 220 Ω .

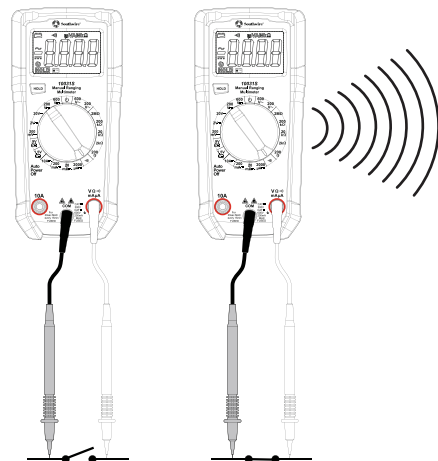

Operation cont.

Testing Batteries

Your Southwire 10031S multimeter can be used to test the remaining voltage capacity in common household batteries.

1. Set the rotary function switch to the **1.5V BATT** or **9V BATT** position
2. Insert the black test into the negative **COM** input jack and the red test lead into the positive **V** input jack.
3. Touch the red test lead probe to the positive (+) side of the battery and the black test lead probe to the negative (-) side of the battery.
4. Read the voltage in the display.

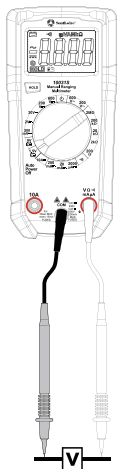

Operation cont.

Replacing the Multimeter 9V Battery

⚠ WARNING: To avoid electric shock, remove test leads from the meter before removing the battery door.

1. When the low battery symbol  appears on the LCD display, replace the battery immediately.
2. Remove the two Phillips screws from the battery/fuse cover located on the back of the meter. (Lift the kickstand to access the bottom screw.)
3. Remove the battery/fuse cover.

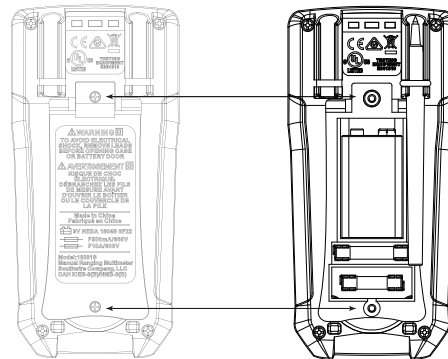

4. Replace battery with a new 9V battery.
5. Re-install battery cover and carefully tighten the screws. Do not overtighten the screws

⚠ WARNING: To avoid electric shock, do not operate your meter until the battery and fuse covers are in place and fastened securely.

Operation cont.

Replacing a Multimeter Fuse

⚠ WARNING: To avoid electric shock, remove test leads from the meter before removing the battery/fuse door.

If you believe one or both fuses in the multimeter have been damaged, you can remove the fuse(s) and use your multimeter to verify whether it is good or bad. Measure the resistance of the fuse by setting the meter dial position to the $2M\Omega$ position. Put the test leads on opposite sides of the fuse and observe the resistance reading. If the resistance is very low, (close to 0 ohms), the fuse is still good. If it's very high or the meter displays "OL" (open circuit), then the fuse is probably not usable.

Your Southwire multimeter has been designed to allow fuses to be easily replaced. The fuses are located in the battery compartment

1. Remove the two Phillips screws from the battery/fuse cover located on the back of the meter. (Lift the kickstand to access the bottom screw.)
2. Remove the battery/fuse cover.

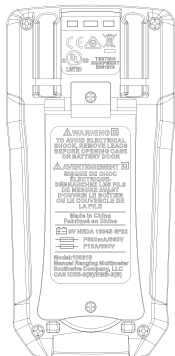

3. Remove the old fuse from its holder by gently pulling it out. A small pair of needle nose pliers are a useful tool for removing old fuses. Grip the fuse tightly and pull it straight out.
4. Install the new fuse into the fuse holder.
5. Always replace a blown fuse with a new fuse of the identical size and rating (Fuse 1: UL rated 500mA/660V fast blow fuse, Fuse 2: UL rated 10A/600V fast blow fuse). Notice that the size of the fuse is printed on the circuit board beneath the fuses.

Operation cont.

6. Install battery/fuse cover and tighten screws. Do not overtighten the screws.

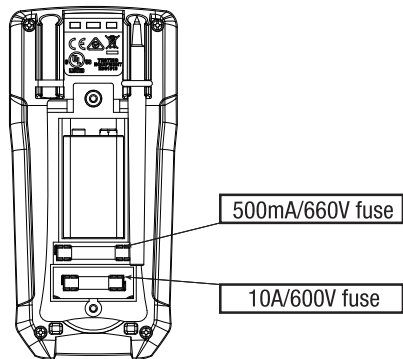

⚠ WARNING: To avoid electric shock, do not operate your meter until the battery/fuse door is in place and fastened securely.

Specifications

Function	Range	Resolution	Accuracy (% of reading + digits)
DC Voltage	200.0mV	0.1mV	$\pm(0.8\% + 8 \text{ digits})$
	2.000V	1mV	
	20.00V	10mV	$\pm(0.5\% + 5 \text{ digits})$
	200.0V	0.1V	
	600V	1mV	
All ranges are specified from 10% to 100% of range			
AC Voltage	200.0mV	0.1V	$\pm(1.2\% + 10 \text{ digits})$
	600V	1V	
	All ranges are specified for a sinewave from 10% to 100% of range Bandwidth: 45 to 400Hz		
DC Current	2000 μ A	1 μ A	$\pm(1.0\% + 5 \text{ digits})$
	20.00mA	10 μ A	
	200.0mA	0.1mA	$\pm(1.2\% + 5 \text{ digits})$
	10.00A	10mA	
Resistance	200.0 Ω	0.1 Ω	$\pm(0.8\% + 5 \text{ digits})$
	2.000k Ω	1 Ω	
	20.00k Ω	10 Ω	
	200.0k Ω	100 Ω	
	2.000M Ω	1 Ω	$\pm(1.0\% + 5 \text{ digits})$
Battery Test	1.5V	1mV	$\pm(1.0\% + 5 \text{ digits})$
	9V	10mV	

NOTE: Accuracy is stated at 64°F to 82°F (18°C to 28°C) and less than 75% RH.

Specifications cont.

Test Lead Storage

Your Southwire 10031S multimeter was designed with test lead holders on the back of the multimeter. You can conveniently store your test leads by inserting them in the test lead holders. You can also use one of the test lead holders as a “third hand”. This allows you to hold the multimeter and one of the test leads in one hand while you hold the second test lead in the other hand. Then you don’t need three hands.

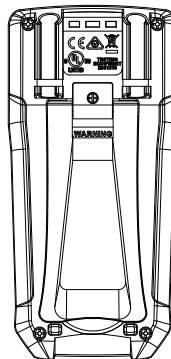

Magnetic Hanging Strap

A convenient accessory is available for your multimeter called the Magnetic Hanging Strap. The strap attaches to the back of your multimeter allowing you to hang your multimeter on metal surfaces. Contact your retailer or electrical distributor to order the Magnetic Hanging Strap, Southwire Model # 60151R.

Accessories

To view available accessories for your new meter, visit southwiretools.com

Customer Service

For technical questions related to your multimeter or information on how to purchase fuses or Southwire accessories, contact Southwire Customer Service at 1-855-SW-TOOLS

Professional Meter Calibration

For information on Southwire's meter calibration service, visit our website at southwiretools.com. Once there, click on the Test and Measurement page. Then find the product page for your meter. There you'll find a link to our Meter Calibration service.

PRODUCT COMPLIANCE



Users of this product are cautioned not to make modifications or changes that are not approved by Southwire Company, LLC. Doing so may void the compliance of this product with applicable laws and regulatory requirements and may result in the loss of the user's authority to operate the equipment.

UNITED STATES AND CANADA

This device complies with Part 15 of the FCC Rules. Operation is subject to the following two conditions: (1) This device may not cause harmful interference, and (2) this device must accept any interference received, including interference that may cause undesired operation.

This equipment has been tested and found to comply with the limits for a Class B digital device, pursuant to Part 15 of the FCC Rules. These limits are designed to provide reasonable protection against harmful interference in a residential installation. This equipment generates uses and can radiate radio frequency energy and, if not installed and used in accordance with the instructions, may cause harmful interference to radio communications. However, there is no guarantee that interference will not occur in a particular installation. If this equipment does cause harmful interference to radio or television reception, which can be determined by turning the equipment off and on, the user is encouraged to try to correct the interference by one or more of the following measures:

- Reorient or relocate the radio or television receiving antenna.
- Increase the separation between the computer equipment and receiver.
- Connect the equipment into an outlet on a circuit different from that to which the radio or television receiver is connected.
- Consult the dealer or an experienced radio television technician for help.

CAUTION: To comply with the limits of the Class B device, pursuant to Part 15 of the FCC Rules, this device is to comply with Class B limits. All peripherals must be shielded and grounded. Operation with non-certified peripherals or non-shielded cables is likely to result in interference and reception of the device.

Canadian Digital Apparatus Compliance

CAN ICES-3(B)/NMB-3(B)

EUROPEAN UNION

In accordance with CE requirements, the Declaration of Conformity may be found at www.southwiretools.com.

REGISTER YOUR PRODUCT

Register your product purchase at www.southwiretools.com.

At Southwire, we are dedicated to providing you with the best customer experience. By following a few quick steps to register, you can experience quicker service, more efficient support, and receive information on our future products. Simply provide your model number, serial number, and just a few pieces of information about yourself – it is that quick and easy.

LIMITED WARRANTY AND LIMITATION OF LIABILITY ON SOUTHWIRE METERS & TESTERS

Southwire Company, LLC. warrants this product to be free from defects in material and workmanship for five years from the date of purchase. This warranty does not cover fuses, disposable batteries, or damage arising from an accident, neglect, misapplication, contamination, modification, improper maintenance or repair, operation outside of specifications, or abnormal handling of the product. Southwire's sole liability, and the purchaser's exclusive remedy, for any breach of this warranty is expressly limited to Southwire's repair or replacement of the product. Whether Southwire repairs or replaces the product will be a determination that Southwire makes at its sole discretion.

SOUTHWIRE MAKES NO WARRANTY THAT THE PRODUCT WILL BE MERCHANTABLE OR FIT FOR ANY PARTICULAR PURPOSE. SOUTHWIRE MAKES NO OTHER WARRANTY, EXPRESSED OR IMPLIED, OTHER THAN THE WARRANTY SPECIFICALLY SET FORTH HEREIN. SOUTHWIRE WILL NOT BE LIABLE FOR ANY INCIDENTAL, CONSEQUENTIAL, INDIRECT, SPECIAL, OR PUNITIVE DAMAGES FOR ANY BREACH OF THIS WARRANTY.

This warranty is void if this product is used for rental purposes. No product reseller is authorized to extend any other warranty on Southwire's behalf relating to this product, and no such reseller warranty will be binding on Southwire. If you have a warranty claim, or if the product needs to be serviced during or after the warranty period set forth above, please contact the Customer Service Department at 855-SWTOOLS (855-798-6657).

The sender is responsible for all shipping, freight, insurance, and packaging costs associated with sending a product to Southwire. Southwire will not be responsible for lost or damaged products returned pursuant to this warranty.

All products returned to Southwire under this warranty should be mailed to:

Southwire Company, LLC.

Attention: Tool Warranty Return

840 Old Bremen Road

Carrollton, GA 30117